

GL 58 J - Truck mounted work platform

Technical data**

Max. working height	57,50 m
Max. platform height	55,50 m
Max. Outreach	40,00 m
Overall dimensions LxBxH	12,10 x 2,52 x 3,82 m
Platform size BxT	3,60* x 0,90 m
Max. lifting capacity	500 kg
Swivel range	+/- 250°
Wheel pressure	220 kN
Ground clearance	0,25 m
Jacking vertical	2,85 m
Jacking unilaterally	6,24 m
Jacking both sides	9,62 m
Jacking length	7,12 m
Weight	25.660 kg
Total weight	26.000 kg
Driver licence	only with operator

Special features

Rotatable cage	yes/2x90°
Jib, rotating angle	yes/180°

**Technical data was captured accurately but may vary within one model series.

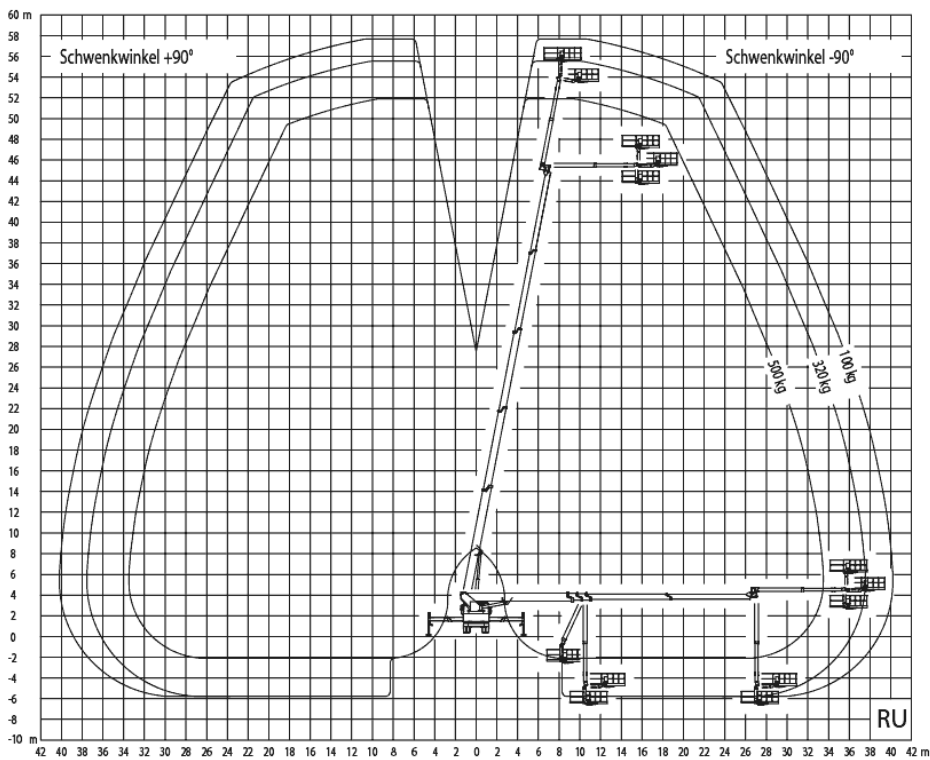
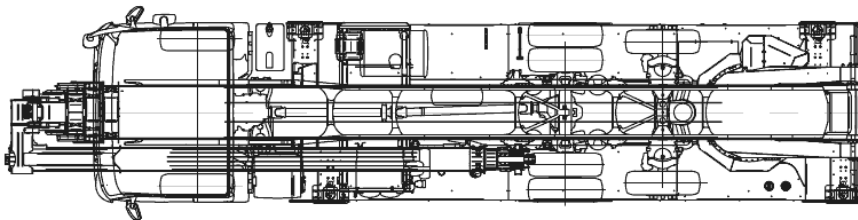
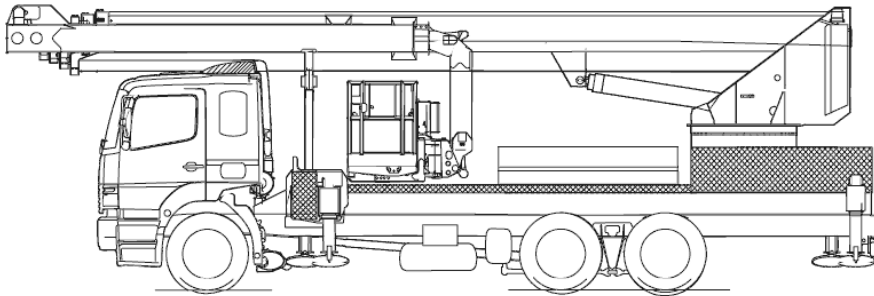

GL 58 J Jacking both sides

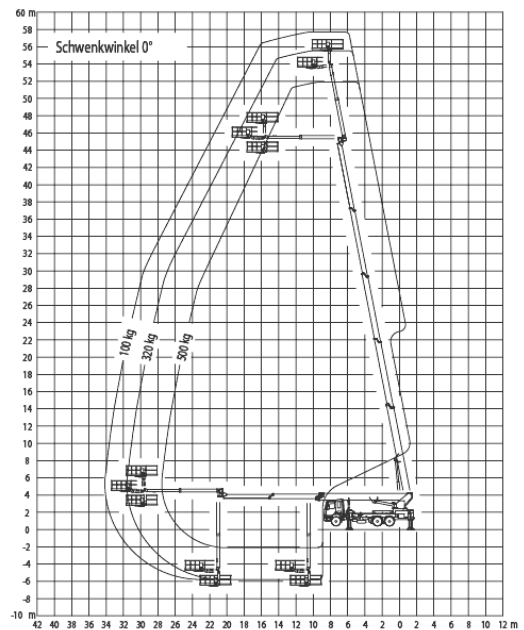
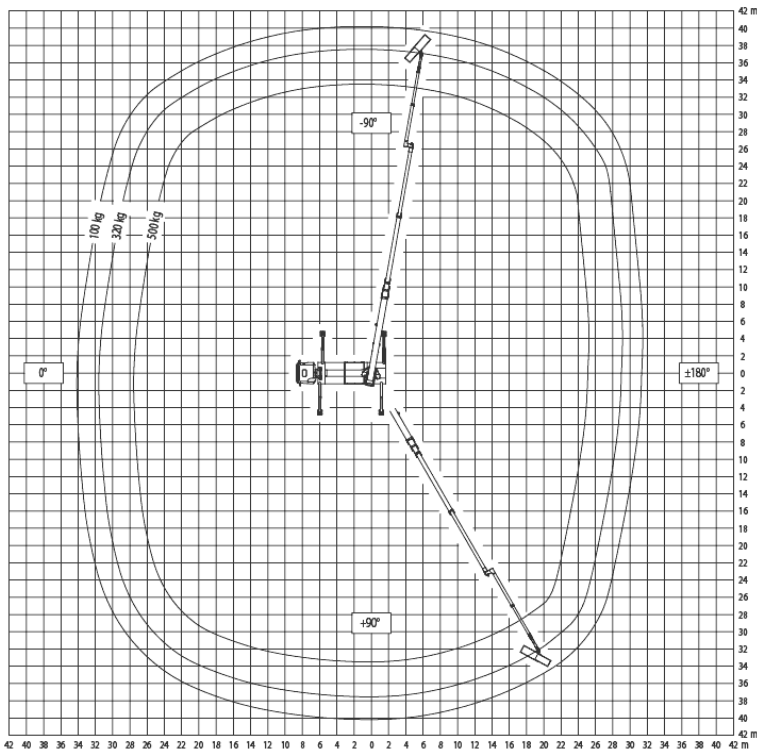
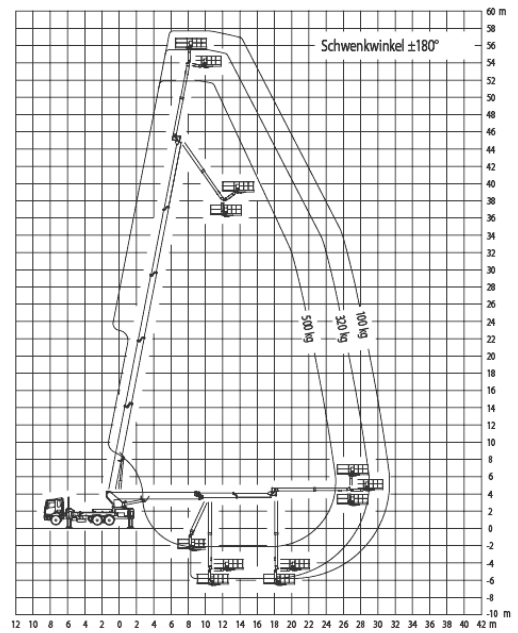
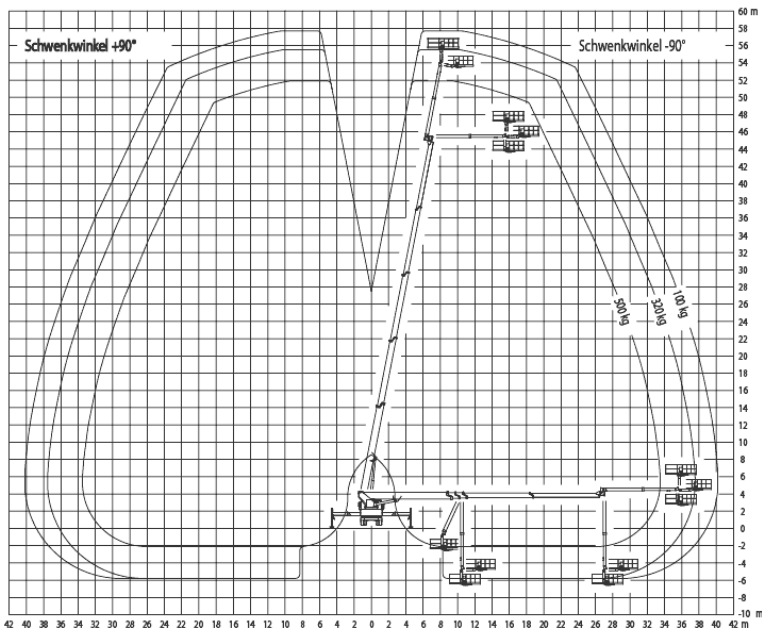

GL 58 J Jacking both sides (25 percent)

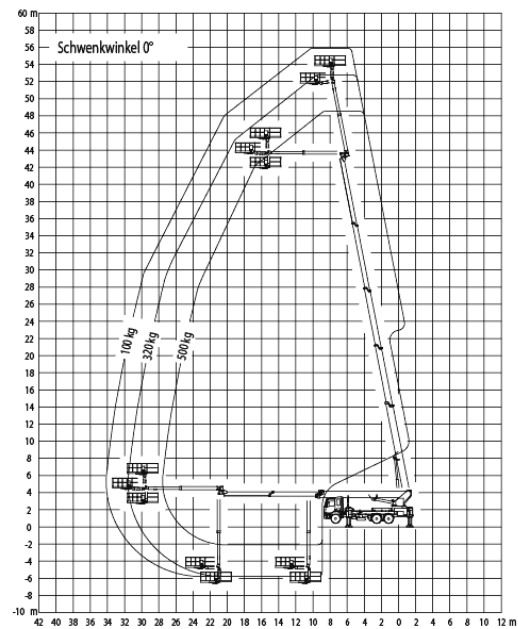
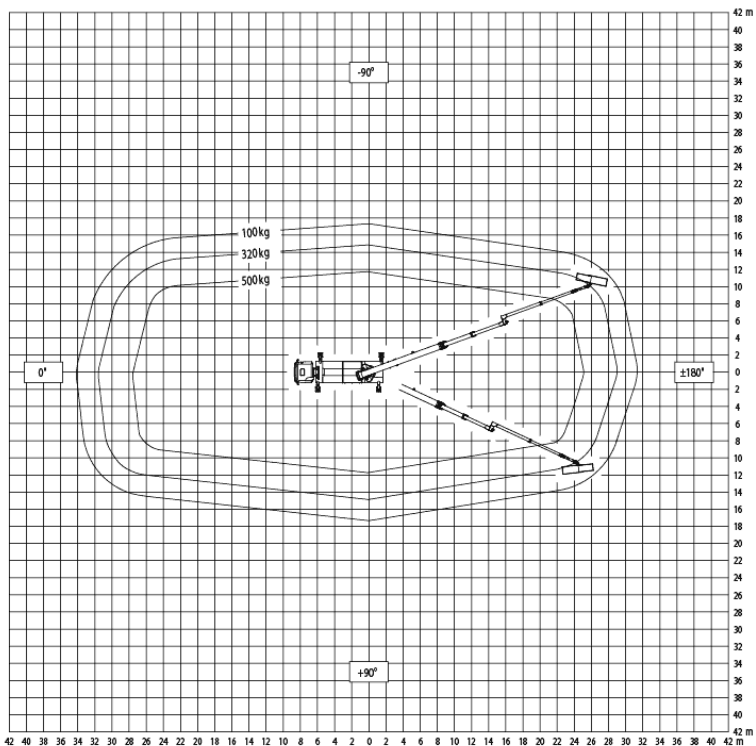
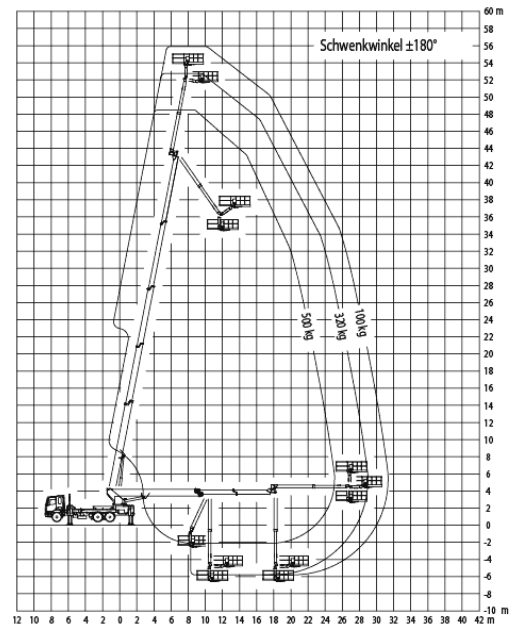
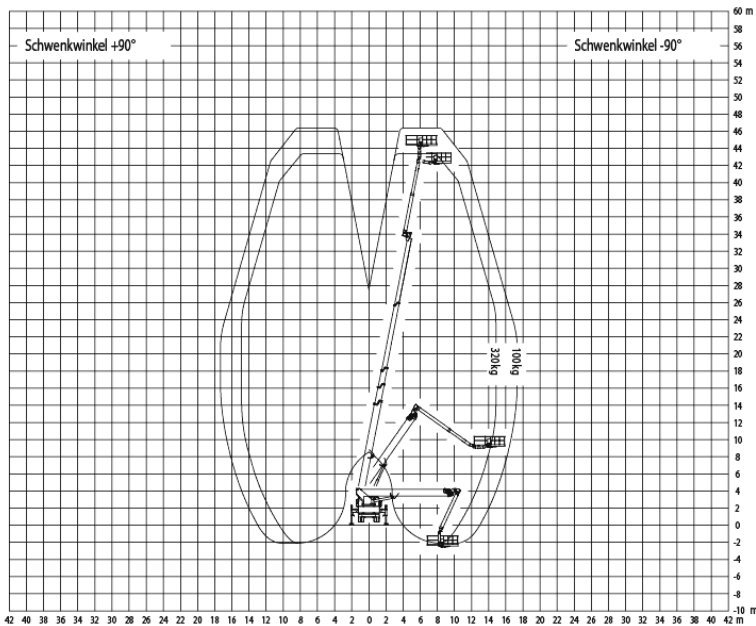

GL 58 J Jacking vertical

