

GL 58 J - Autohoogwerker

Specificatie**:

Max. Werkhoogte	57,50 m
Max. Platformhoogte	55,50 m
Zijdelings bereik	40,00 m
Totale afmetingen LxBxH	12,10 x 2,52 x 3,82 m
Platform afmetingen	3,60* x 0,90 m
Max. Heflast	500 kg
Zwenkbereik	+/- 250°
Stempeldruk (wieldruk)	220 kN
Bodemvrijheid	0,25 m
Afstempeling verticaal	2,85 m
Afstempeling eenzijdig	6,24 m
Afstempeling tweezijdig	9,62 m
Afstempeling lengte	7,12 m
Gewicht	25.660 kg
Eigen gewicht	26.000 kg
Rijbewijs	inhuur met bedieningspersoneel

Extra:

Draaibare werkbak	ja 2x90°
Jib-arm - Draaihoek	ja/180°

2 jibs met elk 180° draaihoek, generator 4 KVA/230 V voor onafhankelijke stroomverzorging in de werkbak, volautomatisch afstempelautomaat, kleine draaicirkel dankzij gestuurde 3e as, *ingeschoven dan 2,30 m

**De technische gegevens worden exact opgemeten, maar kunnen binnen een serie onderling variëren.

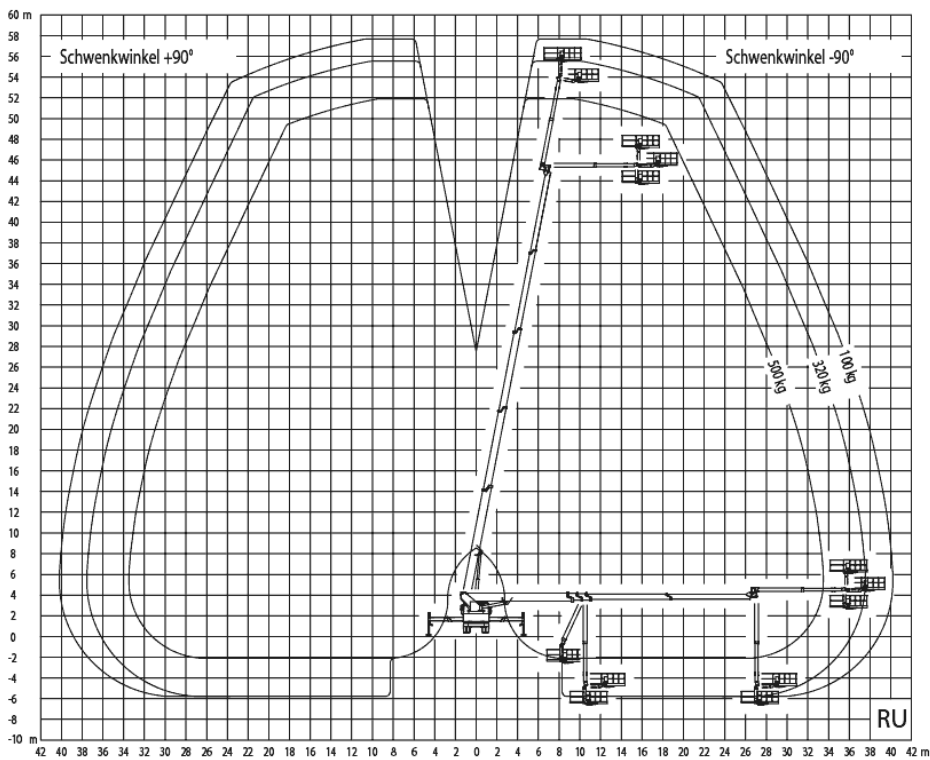
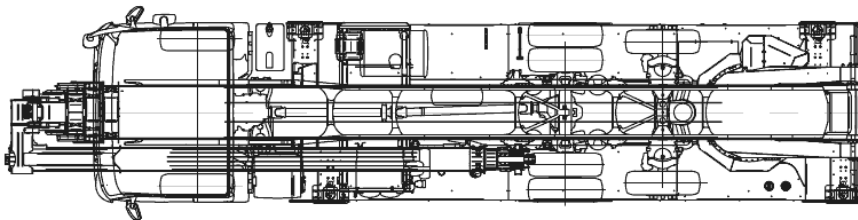
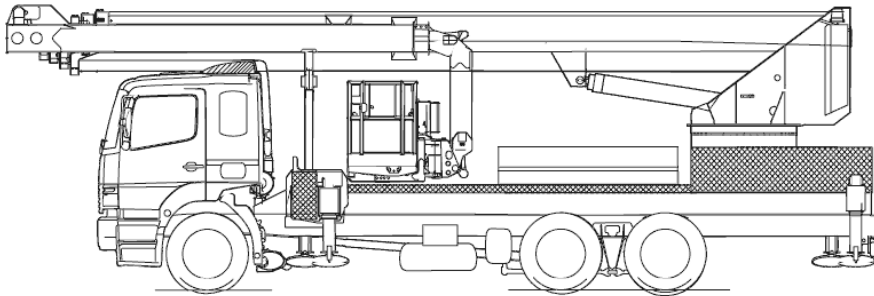

GL 58 J Afstempeling tweezijdig

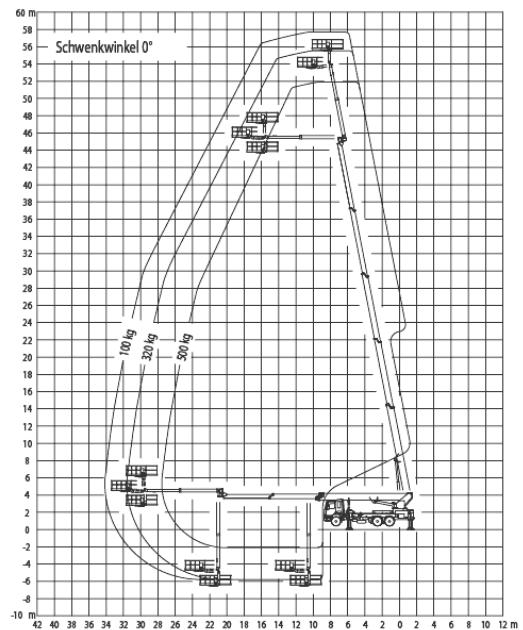
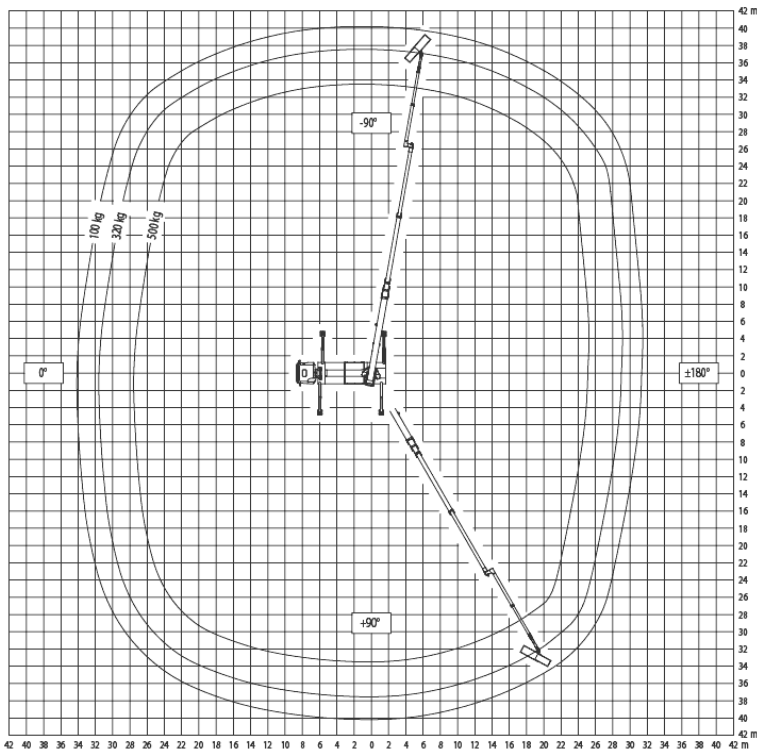
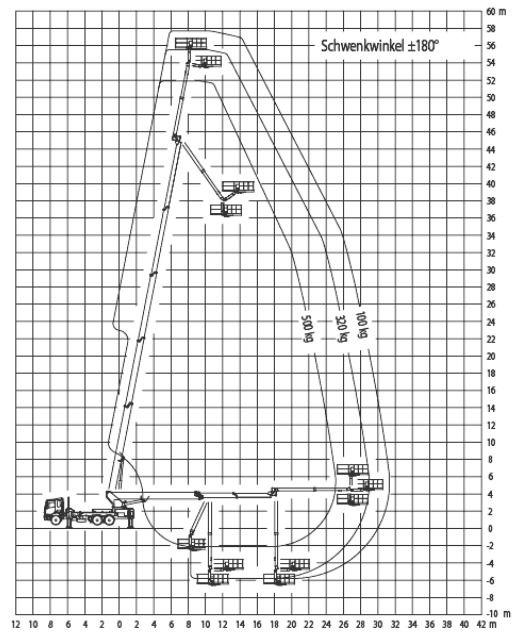
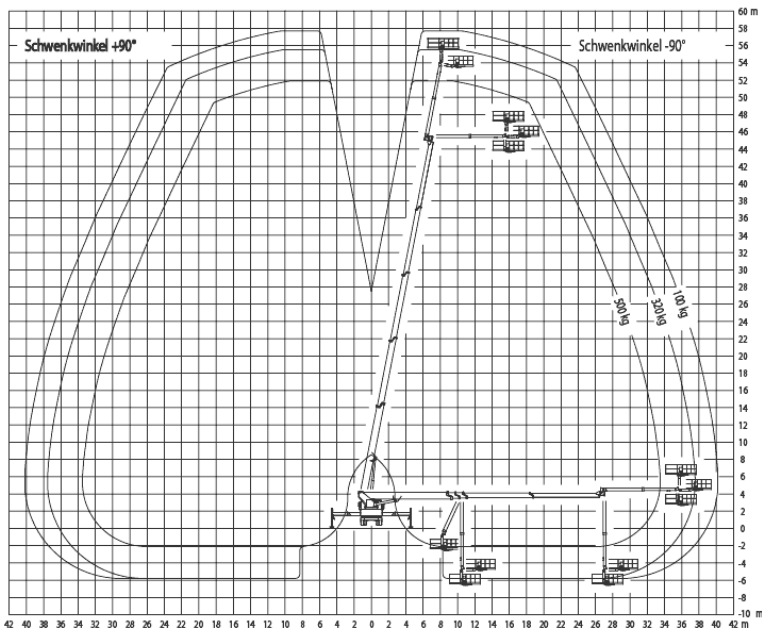

GL 58 J Afstempeling tweezijdig (25 percent)

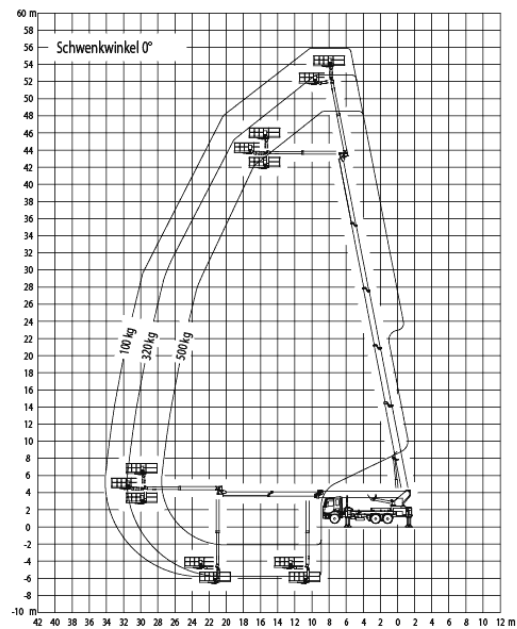
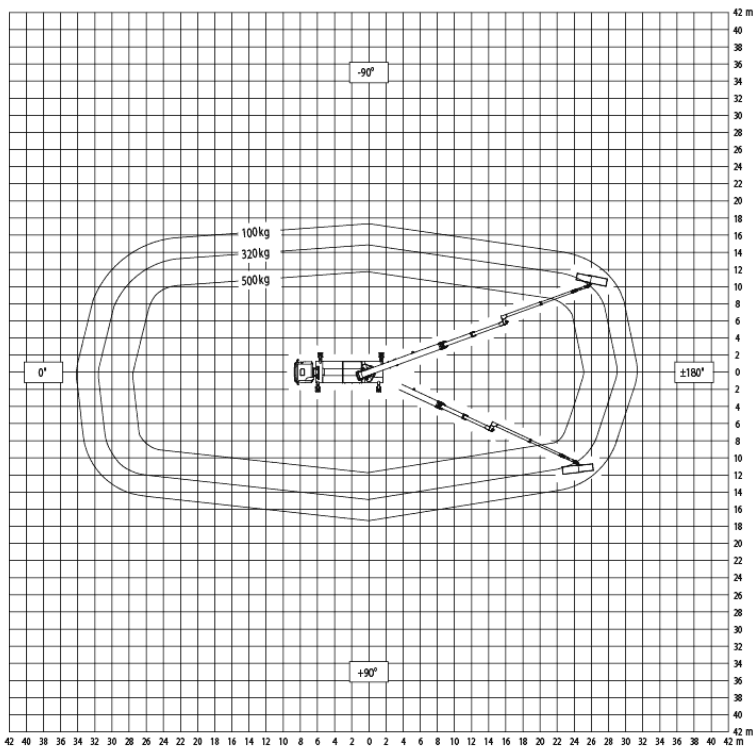
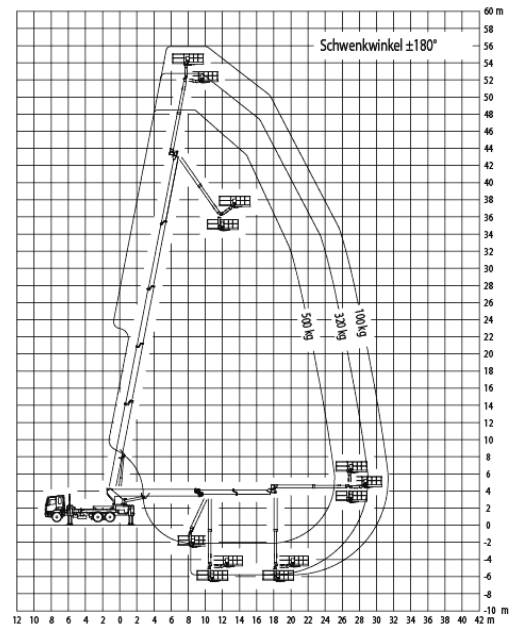
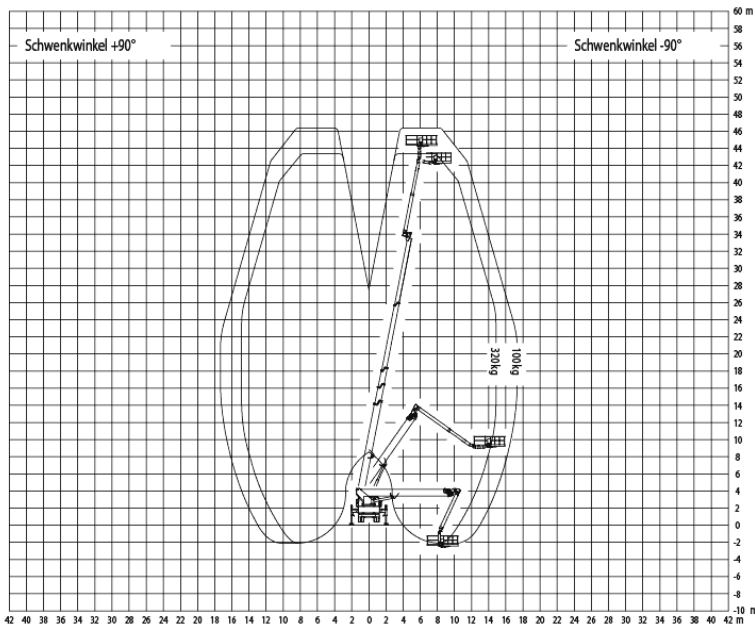

GL 58 J Afstempeling verticaal

