

## GL 58 H Allrad - Autohoogwerker

Specificatie\*\*:

<b>Max. Werkhoogte</b>	57,50 m
<b>Max. Platformhoogte</b>	55,50 m
<b>Zijdelings bereik</b>	40,00 m
<b>Totale afmetingen LxBxH</b>	12,10 x 2,52 x 3,82 m
<b>Platform afmetingen</b>	3,60* x 0,90 m
<b>Max. Heflast</b>	500 kg
<b>Zwenkbereik</b>	+/- 250°
<b>Stempeldruk (wieldruk)</b>	220 kN
<b>Bodemvrijheid</b>	0,25 m
<b>Afstempeling verticaal</b>	2,85 m
<b>Afstempeling eenzijdig</b>	6,24 m
<b>Afstempeling tweezijdig</b>	9,62 m
<b>Afstempeling lengte</b>	7,12 m
<b>Gewicht</b>	25.660 kg
<b>Eigen gewicht</b>	26.000 kg
<b>Rijbewijs</b>	inhuur met bedieningspersoneel

Extra:

<b>Draaibare werkbak</b>	ja 2x90°
<b>Jib-arm - Draaihoek</b>	ja/

2 jibs met elk 180° draaihoek, vol automatisch afstempelautomaat, 4x4, sperdifferentieel en ruwterrein banden, ideaal voor ruw terrein, kleine draaicirkel dankzij gestuurde 3e as, \*ingeschoven dan 2,30 m, Info: Verhuur alleen met bedienend personeel

\*\*De technische gegevens worden exact opgemeten,  
maar kunnen binnen een serie onderling variëren.

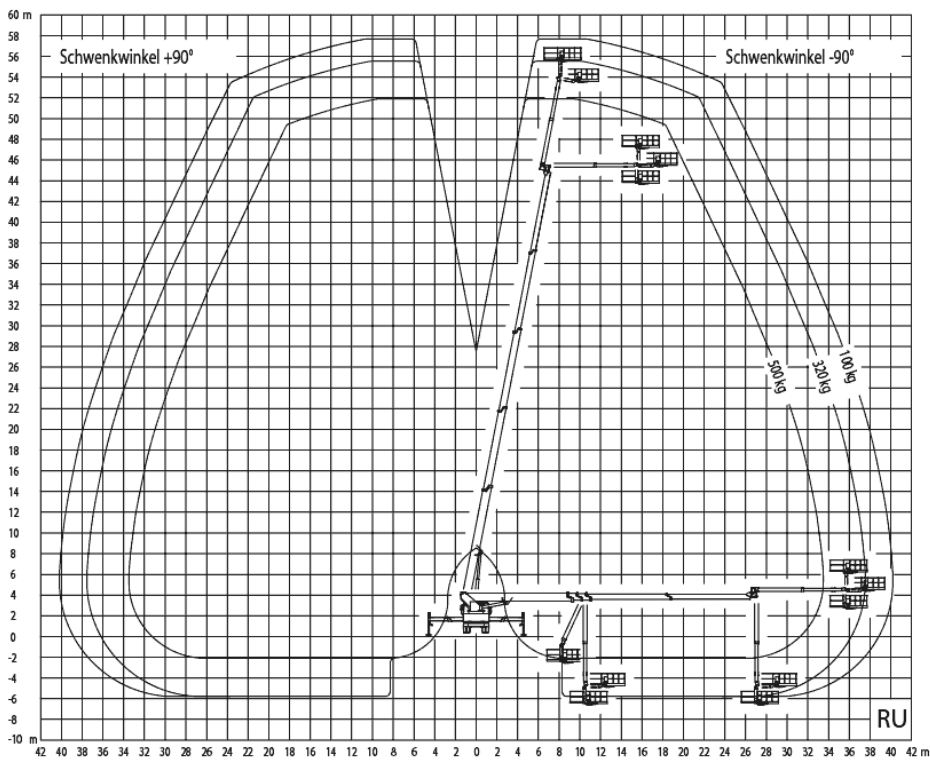
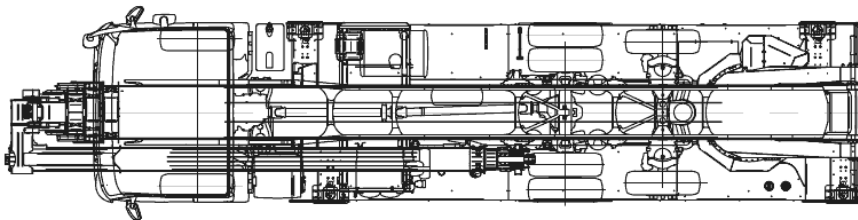
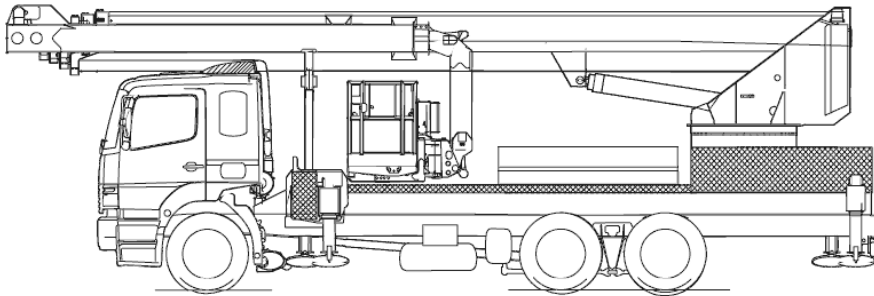

# GL 58 H Allrad Afstempeling tweezijdig

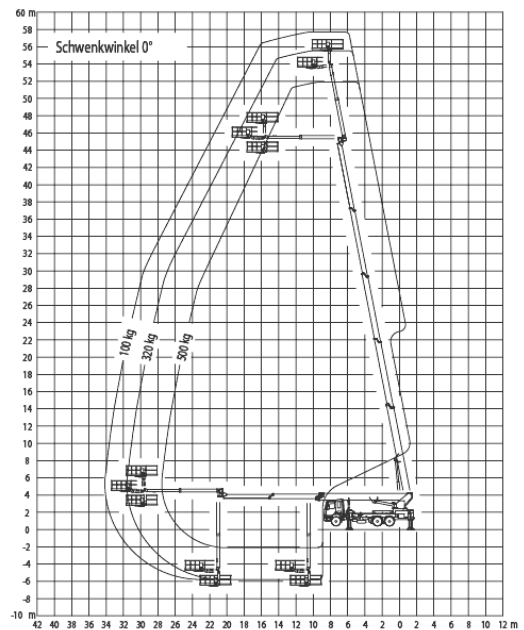
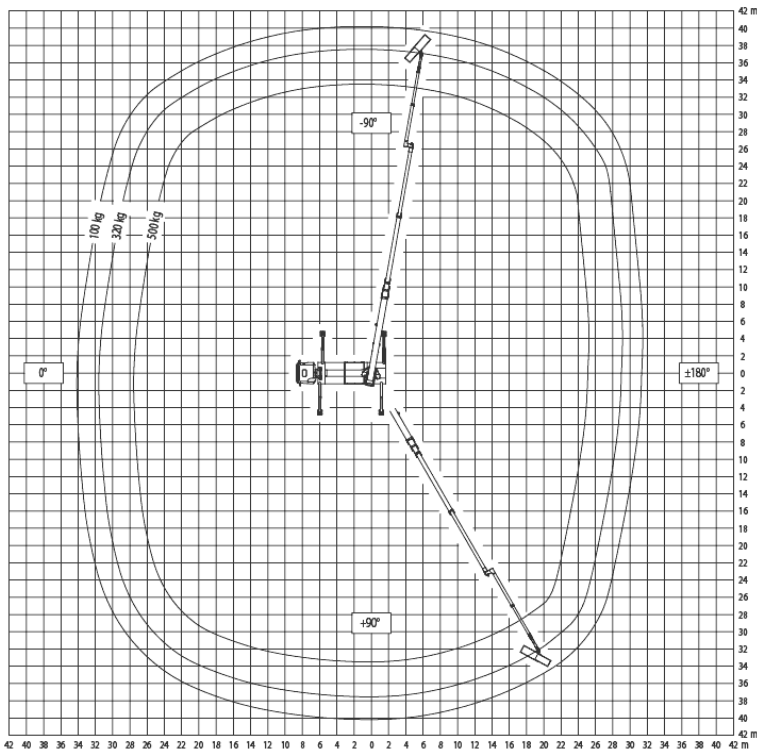
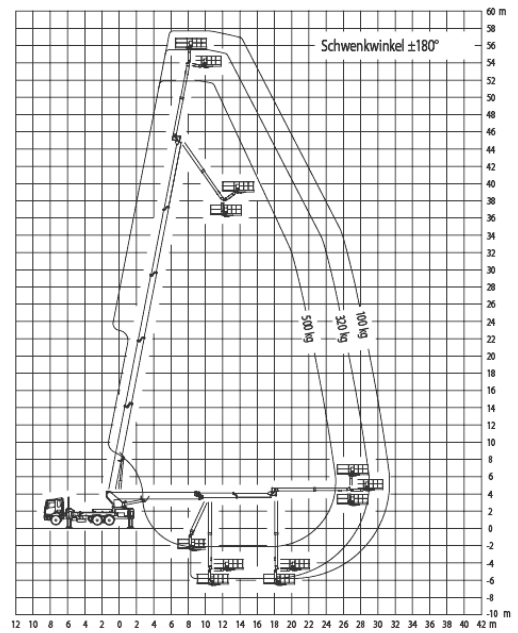
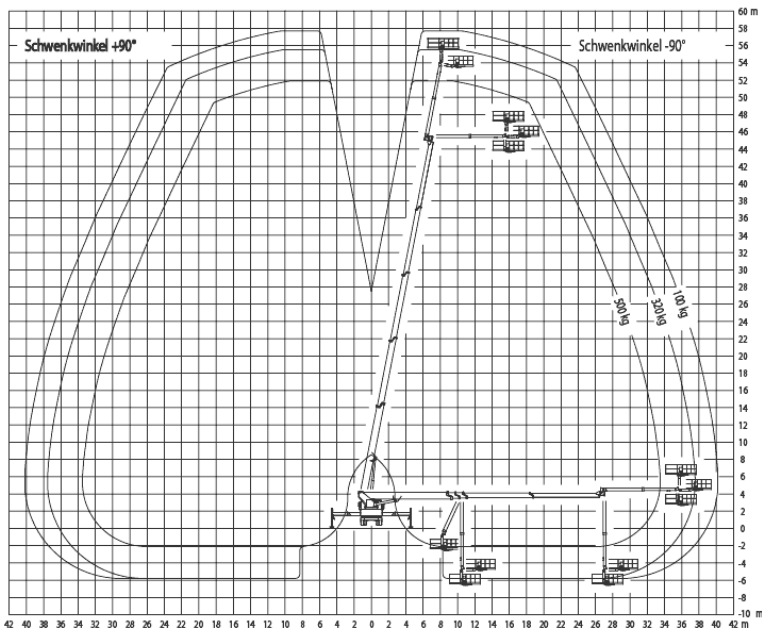

# GL 58 H Allrad Afstempeling tweezijdig (25 percent)

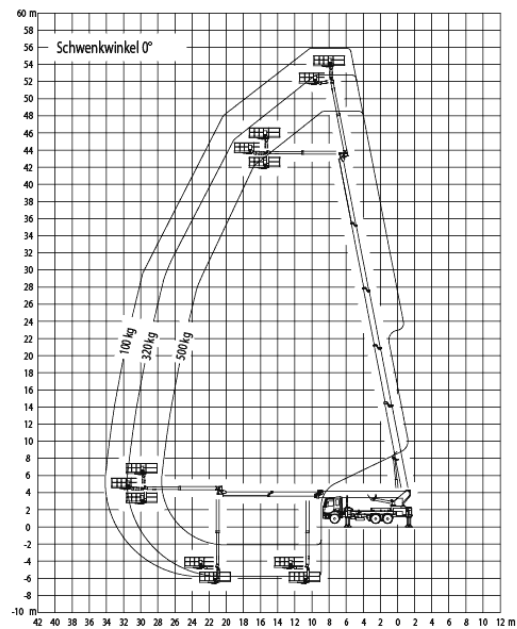
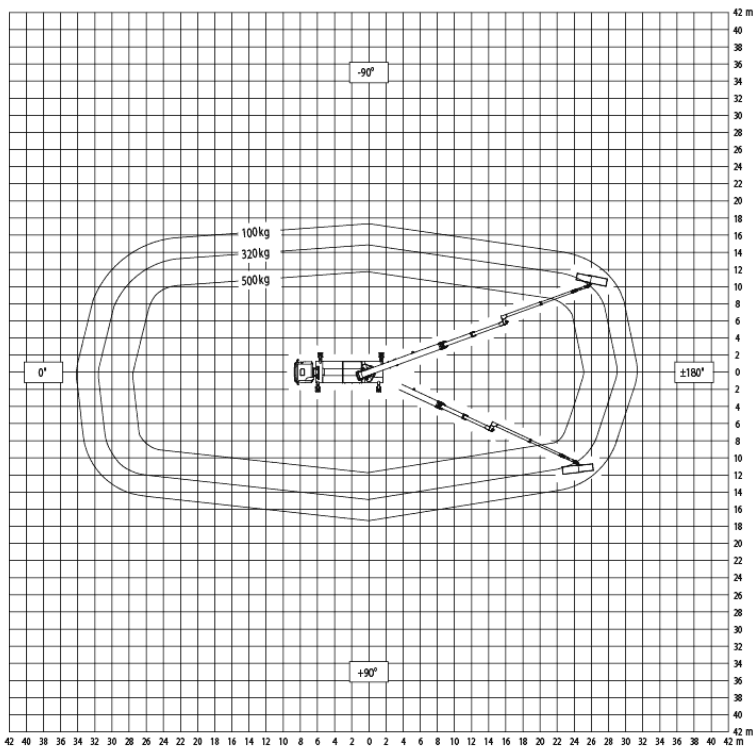
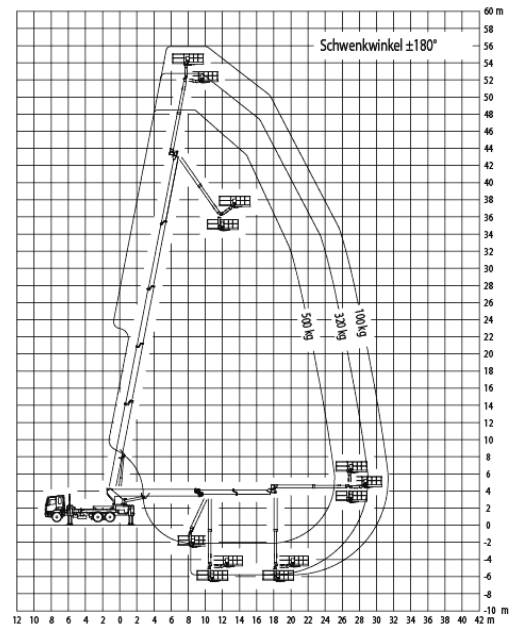
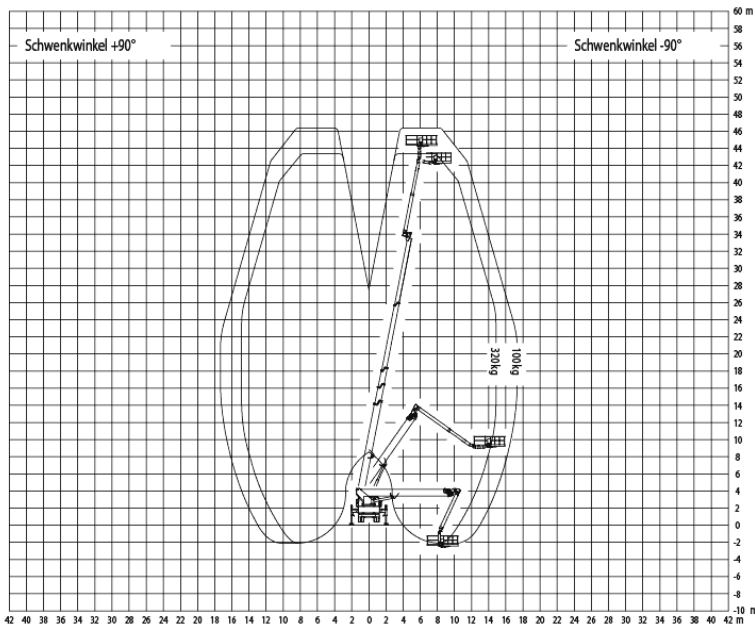

# GL 58 H Allrad Afstempeling verticaal

